

Data Sheet

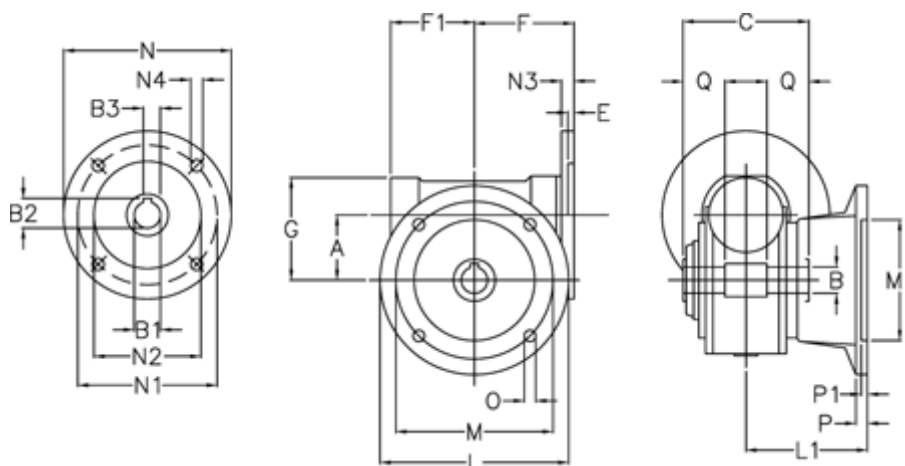

Article number: 390203001042310
Description: Worm gear
VF 30-F2-10-63B14

Measures



A = 30	F1 = 46	N2 = 60
B = 14 H7	G = 50	N3 = 6
B1 E7 = 11	L = 80	N4 = 5.5
B2 = 12.8	L1 = 50.5	O = 6.5
B3 H9 = 4	M = 65	P = 6
C = 55	M1 = 50	P1 = 4
E = 5.5	N = 90	Q = 20.5
F = 52	N1 = 75	